





36 608 985



- rosetta 60 x 60 mm
- parte superiore con perno e boccola accorciabili

	Cromato	36 608 985-00
	Platinato spazzolato	36 608 985-06
	Platinato	36 608 985-08
	Ottone spazzolato (Oro 23k)	36 608 985-28
	Dark Platinum spazzolato	36 608 985-99

Prodotti complementari necessari



- Rubinetto da incasso 3/4" -** 35 608 970 90
- Profondità d'incasso max. 145 mm
 - profondità d'incasso min. 75 mm

36 608 985

mm [inches]

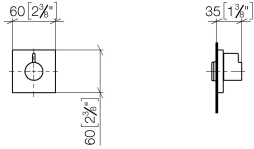

Certificati

IAPMO_4976 (1). WRAS_2010066.

36 608 985

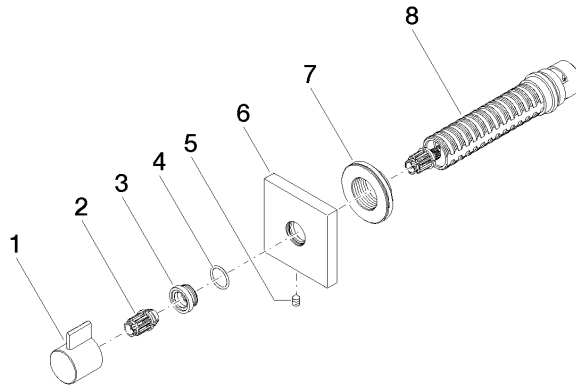

Elenco delle parti di ricambio

N.	Codice articolo	Denominazione	Quantità necessaria	Tempo di produzione
1	09 20 98 002-00	manopola	1	10
2	09 12 12 005 90	bussola a scatto	1	2
3	09 12 12 043-00	alloggio	1	10
4	09 14 10 017 90	guarnizione	1	2
5	90 31 11 004 00 90	perno	1	2
6	09 27 98 014-00	rosetta	1	10
7	09 21 02 151 90	bussola	1	2
8	90 90 03 128 00 90	parte superiore	1	2